



Roller shutters EXTERNAL

GATES | **WINDOWS** | DOORS | FENCES

External roller shutter

PROTECTA

PROTECTA roller shutters ensure that the space that's most important to your family is always protected. This is why we gave this range a name derived from the word "protect". In the summer, they will protect your home from overly intensive sun rays, while in the winter, they keep more heat inside - to help you save on air conditioning and heating bills. Their special design additionally quietens noises coming from the outside and makes your private space a genuine oasis, even when buildings in your neighbourhood are densely arranged. The **PROTECTA** roller shutters are a functional addition to the **PRIMO, DEVELO, and FUTURO** windows.



INSULATION

The PROTECTA roller shutters protect your home against sun, cold, wind, and noise.

They insulate the home interior from everything that can disturb the peace and security of your family.



SMART CONTROL

Thanks to the smartCONNECTED feature, you can control the PROTECTA roller shutters from your phone. You are at work and you want to close the roller shutters so that the strong sun does not overheat the interior? Just do it remotely without having to move one inch.



MODERN DESIGN

The design of the PROTECTA roller shutters is all about timeless elegance. That is why they will match any type of architecture. But they will always look their best when paired with WIŚNIEWSKI windows, garage door, gate, and fence.

Roller shutters for your home **PROTECTA**

WIŚNIEWSKI's external roller shutter systems were adapted to various needs and construction stages. You can choose from several roller shutter types, over a dozen of colours, and a broad range of accessories. Create a product that will harmonize with the home design of your dreams and meet all the needs your family may have.

PROTECTA roller shutter types

PROTECTA P roller shutter

This flush-mounted roller shutter system is mainly intended for use in newly built houses. It can also be used when retrofitting the building's insulation or modernizing the current one – provided that the required changes in the lintel are made.

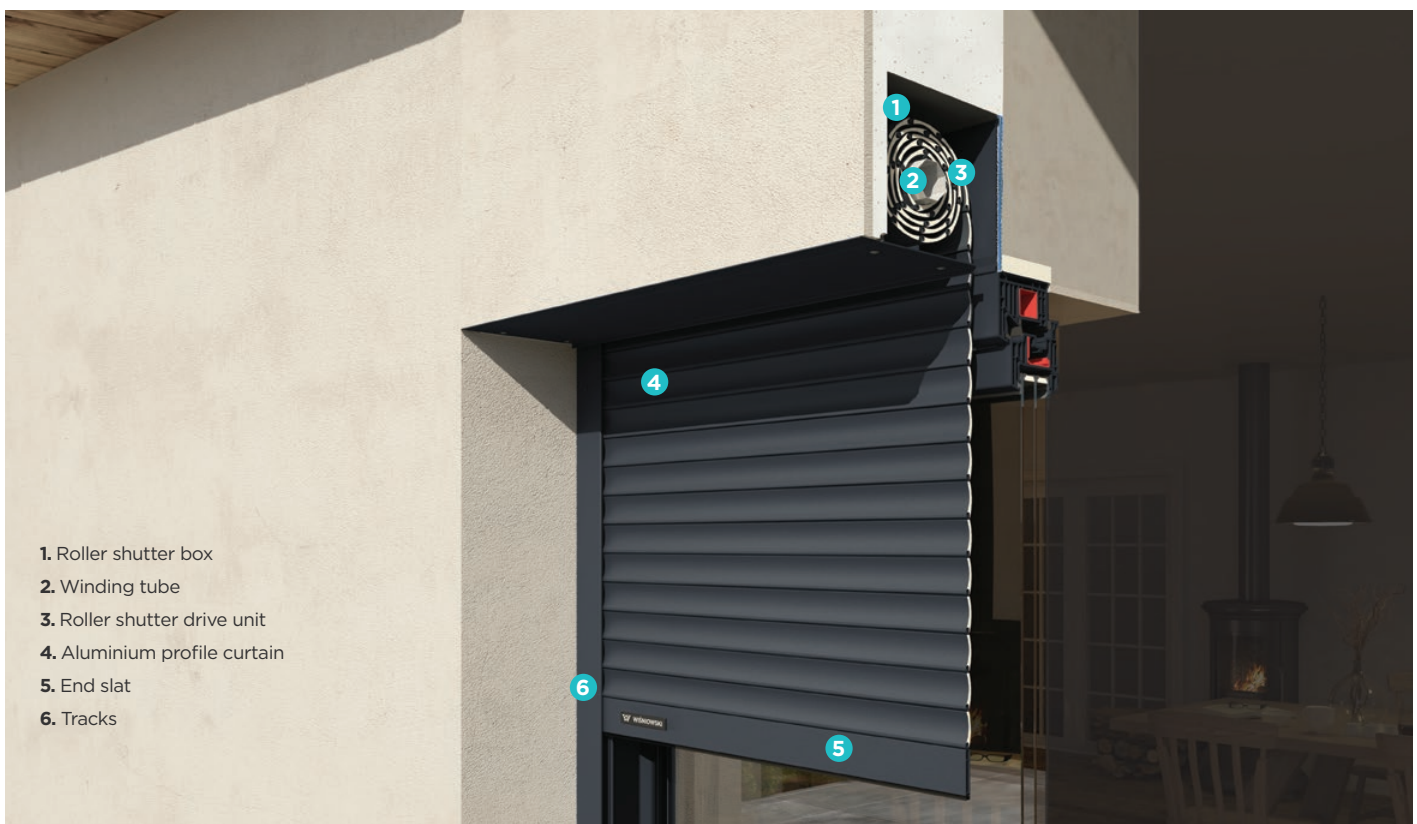

1. Roller shutter box
2. Winding tube
3. Roller shutter drive unit
4. Aluminium profile curtain
5. End slat
6. Tracks

Roller shutter characteristics:

A flush-mounted system for buildings, where a proper preparation of the lintel is required.

- 6 non-perforated slats from the top
- steel/PVC soft hangers with felt
- end slat 51 mm high
- end slat caps with a fixed bumper
- guide rails with a brush seal
- access cover fixed with rivets
- the top end position is set in the power operated version
- rubber cable gland
- cord winder in colour: white / brown
- plaster bracket for covering 15 mm

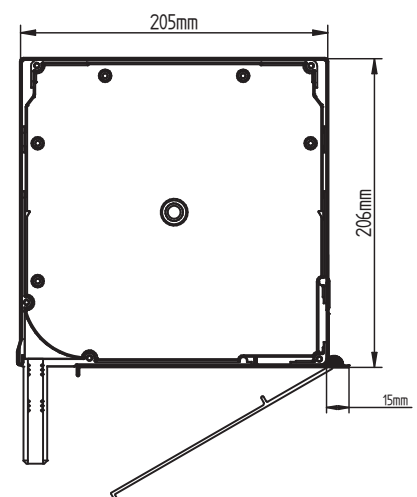

PROTECTA A roller shutter

The Protecta A is a range of external front-mounted roller shutters. They are intended for buildings in which windows have already been fitted or where – for various reasons – other roller shutter systems cannot be used. The selection of the right box colour will make the roller shutters match the windows you chose at an earlier stage.



1. Roller shutter box
2. Winding tube
3. Roller shutter drive unit
4. Aluminium profile curtain
5. End slat
6. Tracks

Roller shutter characteristics:

A flush-mounted system for installation on the already installed windows or the façade.

- 6 non-perforated slats from the top
- steel/PVC soft hangers with felt
- end slat 51 mm high
- end slat caps with a fixed bumper
- guide rails with a brush seal
- access cover fixed with rivets
- the top end position is set in the power operated version
- rubber cable gland
- cord winder in colour: white / brown

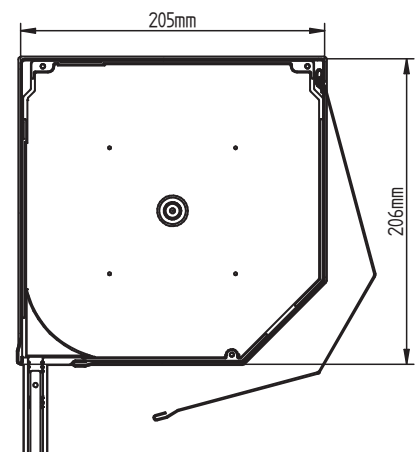

PROTECTA roller shutter types

PROTECTA N roller shutter

A system of top-mounted roller shutters with a PVC box that is mainly used in newly built houses. However, it can also be used in existing buildings, e.g. when the joinery is being replaced. The roller shutter box is placed directly over the window – it is not visible from the outside.



1. Roller shutter box
2. Winding tube
3. Roller shutter drive unit
4. Aluminium profile curtain
5. End slat
6. Tracks

Roller shutter characteristics:

A flush-mounted system for installation on the already installed windows or the façade.

- 6 non-perforated slats from the top
- steel/PVC soft hangers with felt
- end slat 51 mm high
- end slat conical stoppers 30 mm, with MKT 18 mm
- guide rails with a brush seal
- guide rails can be cut at a 5° angle
- the top end position is set in the power operated version
- rubber cable gland
- cord winder in colour: white / brown
- installation anchors
- side cover and window frame connector

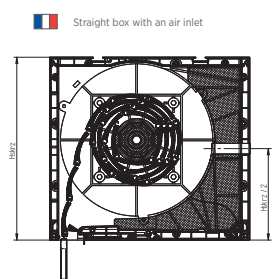
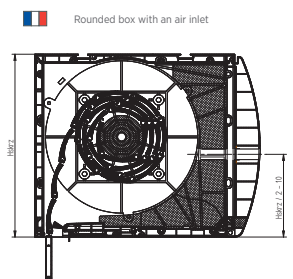
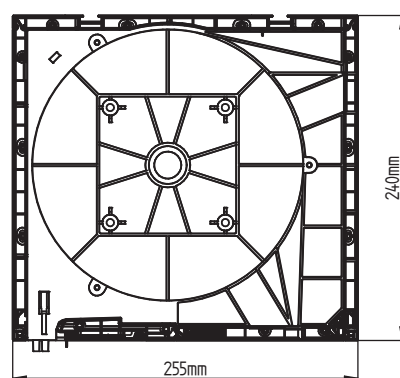

PROTECTA S roller shutter

The **Protecta S** is a roller shutter system with a polystyrene box; the roller shutters can be installed both in newly built buildings and in renovated buildings when the window joinery is being replaced. The box is made of a material providing excellent thermal characteristics. It is fixed above the window.



Roller shutter characteristics:

A flush-mounted system for installation on the already installed windows or the façade.

- 6 non-perforated slats from the top
- steel/PVC soft hangers with felt
- end slat 51 mm high
- end slat conical stoppers 30 mm
- guide rails with a brush seal
- guide rails can be cut at a 5° angle
- the top end position is set in the power operated version
- rubber cable gland
- cord winder in colour: white / brown
- installation anchors
- side cover and window frame connector

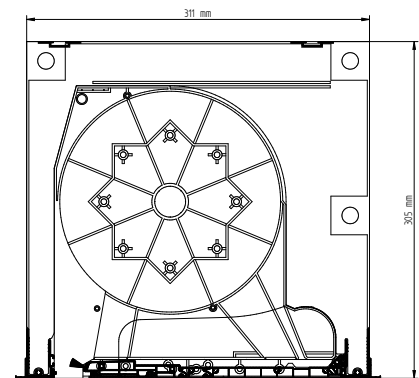

Accessories

for external roller shutters

PREMIUM Somfy automatic operating units



Wired motor with obstacle detection (Somfy Solus P&P VVF)

Wired motor with mechanical limit switches (Somfy Solus 2PA)

Cable and wireless hybrid motor
Two types of control - wired and wireless, automatic detection of the direction of rotation, as well as automatic or fixed adjustment of the limit positions (Somfy RS100 io Hybrid)

io wireless motor
Automatic detection of the direction of rotation, as well as automatic or fixed adjustment of the limit positions (Somfy RS100 io)

io wireless motor with obstacle detection and automatic limit switches (Somfy Oximo io)



Self-locking hook
Somfy LOCK TO PLAY



Situio io II remotes by
Somfy using the io technology



Smooove 1 io - wireless
wall-mounted transmitter

STANDARD Aluprof automatic operating units



Wired motor with mechanical limit switches, controlled with a pushbutton switch.

Wired motor with overload detection, with built-in electronic limit switches controlled with a pushbutton switch.

Wireless motor with a built-in receiver and mechanical limit switches, controlled with the DC series wireless transmitters.

Wireless motor with a built-in receiver and electronic limit switches, controlled with the DC series wireless transmitters. Compatible with a bell switch.

CURTAIN types



Perforated curtain



Non-perforated curtain

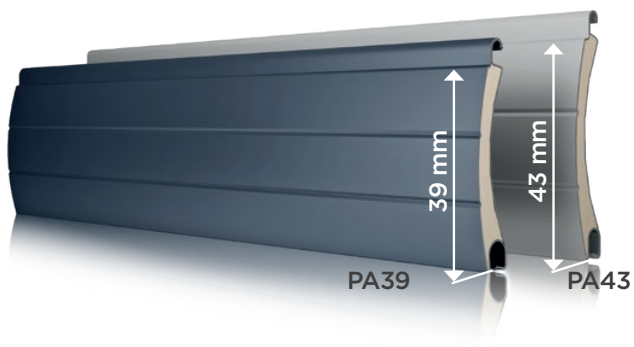

The curtain without perforation ensures full insulation from the wind and sun, while the perforated version enables room ventilation when the roller shutter is slightly lifted in the closed position. The perforation additionally subtly brightens the home interior.

Curtain types

PA39 curtain - max. surface area 6 m², max. width - 3,200 mm,

PA43 curtain - max. surface area 9 m², max. width - 3,300 mm.



Live more comfortably with smartCONNECTED

Manage your home with WIŚNIEWSKI products automatically, no matter where life takes you



YOUR APP BENEFITS

COMPATIBILITY

control the garage door, door, roller shutters, and more

SAFETY

the app is protected with your individual access code

VOICE ASSISTANT

control your home appliances with your voice after connecting the Google voice assistant

REMOTE CONTROL

manage your home, check its status, and automate smart devices from any place in the world

Roller shutters with the smartCONNECTED smart control that can be controlled remotely with your smartphone or tablet. You can easily adjust how much light reaches your home interior and control the level of privacy in the room without having to physically touch the roller shutters. The smartCONNECTED Box central control unit connects all the devices in a single smart control system. It can include WIŚNIEWSKI garage doors, gates, windows, doors, and roller shutters, as well as many other home elements that take advantage of the io homecontrol technology.



smartCONNECTED Box

The smartCONNECTED Box is a central control unit that connects all the home devices within a single smart control system. It can include WIŚNIEWSKI garage doors, gates, windows, doors, and roller shutters, as well as many other home elements that can take advantage of the io homecontrol technology, such as shutters and internal shades or blinds.



TaHoma Switch

With the TaHoma Switch, you can control the devices at your home with your smartphone, tablet or computer. A clear interface and an intuitive system make it a system that is easy to use for anyone. Additional, immediate feedback gives you certainty that the tasks were performed properly and no obstacles were encountered.



 smart
CONNECTED



Colours

Apart from the type of roller shutters, you can also pick the colour that will match the windows in your home. The WIŚNIEWSKI PROTECTA roller shutters are available in as many as 22 colour versions. Moreover, you can take advantage of optional accessories and variants to adapt them to your individual needs even better.

Roller shutter curtains

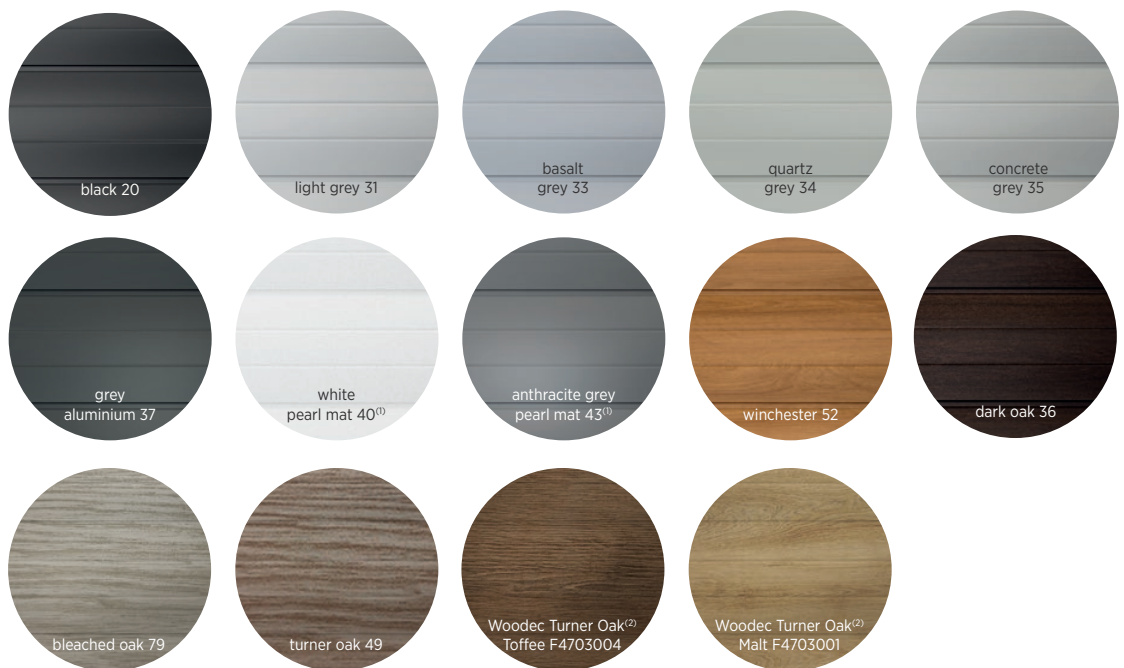
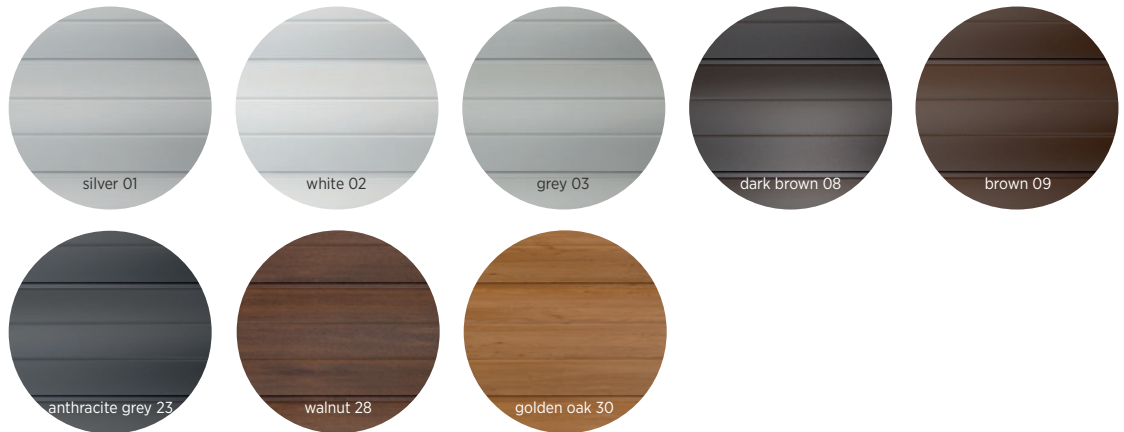
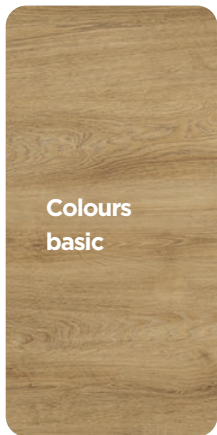

Due to technical considerations, actual colours may differ from those represented in the pictures and photographs. Please consult the dealer upon purchase. (1) PLEASE NOTE! Colours available only with the Pa39 curtain. (2) Colours available only with the BP41R curtain.

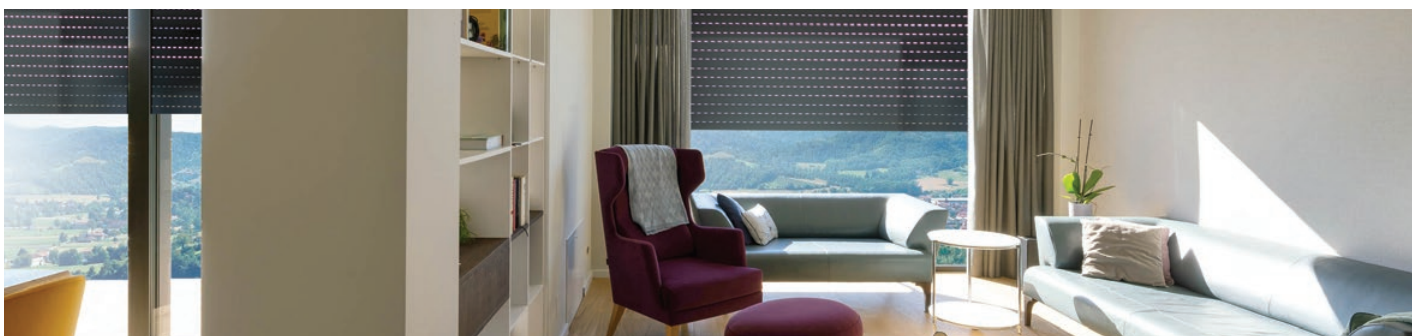



DESIGN

WIŚNIEWSKI roller shutters

Inspiration







Choose

WIŚNIEWSKI windows

Find out for yourself that WIŚNIEWSKI windows are the best choice for you and your home.

Find all the details at:
www.wisniowski.pl/en/for-home/doors-and-windows



Choose a complete set. Garage door, windows, door, gate, and fence that combine the best qualities: excellent design, the highest quality, and modern technologies. It is an ideal combination for your home and everyday comfort!



WIŚNIEWSKI is a leader in the manufacture of garage doors, gates, windows, doors, and fences. We take the best care of our customers to make sure they get solutions perfectly suited to their needs – products that complement their vision and design, and at the same time ensure the highest quality. WIŚNIEWSKI offers fully comprehensive solutions for people who want to make their dream homes a reality and experience them with all their senses. WIŚNIEWSKI is a brand for connoisseurs of perfection in every detail, who understand the importance of quality and want to make it a part of their lives.

WIŚNIEWSKI Sp. z o.o. S.K.A.

33-311 Wielogłowy, Poland

 /WIŚNIEWSKI_official  /WIŚNIEWSKI.group

The products shown in the photographic material often feature special accessories and do not always correspond to their standard versions • This brochure does not constitute an offer within the meaning of the Polish Civil Code. • The manufacturer reserves the right to introduce changes without notice. • NOTE: The colours shown in this brochure are for reference only • All rights reserved • Copying and use, in part or in full, is prohibited without the consent of WIŚNIEWSKI Sp. z o.o. S.K.A. • 04/23/EN

